

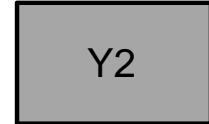

FEATURES

- High Collector Current
- Complementary to SS8050

SOT-23

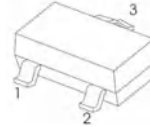

- 1.BASE
2.EMITTER
3.COLLECTOR

MAXIMUM RATINGS AND ELECTRICAL CHARACTERISTICS

MAXIMUM RATINGS (Ta=25°C unless otherwise noted)

Parameter	Symbol	Value	Unit
Collector–Base Voltage	V_{CBO}	-40	V
Collector–Emitter Voltage	V_{CEO}	-25	V
Emitter–Base Voltage	V_{EBO}	-5	V
Collector Current — Continuous	I_C	-1.5	A
Collector Dissipation	P_C	200	mW
Thermal Resistance From Junction To Ambient	R_{thJA}	625	°C/W
Operation Junction and Storage Temperature Range	T_J, T_{stg}	-55~+150	°C

CLASSIFICATION OF $h_{FE(1)}$

RANK	L	H	J
RANGE	120-200	200-350	300-400
MARKING	Y2		

ELECTRICAL CHARACTERISTICS (TA = 25°C unless otherwise noted.)

Parameter	Symbol	Test conditions	Min	Typ	Max	Unit
Collector-base breakdown voltage	$V_{(BR)CBO}$	$I_C = -100\mu A, I_E = 0$	-40			V
Collector-emitter breakdown voltage	$V_{(BR)CEO}$	$I_C = -0.1\text{ mA}, I_B = 0$	-25			V
Emitter-base breakdown voltage	$V_{(BR)EBO}$	$I_E = -100\mu A, I_C = 0$	-5			V
Collector-base cut-off current	I_{CBO}	$V_{CB} = -40V, I_E = 0$			-0.1	μA
Collector-emitter cut-off current	I_{CES}	$V_{CE} = -20V, V_{BE} = 0$			-0.1	μA
Emitter-base cut-off current	I_{EBO}	$V_{EB} = -5V, I_C = 0$			-0.1	μA
DC current gain	h_{FE1}	$V_{CE} = -1V, I_C = -100\text{ mA}$	120		400	
	h_{FE2}	$V_{CE} = -1V, I_C = -800\text{ mA}$	40			
Collector-emitter saturation voltage	$V_{CE(sat)}$	$I_C = -800\text{ mA}, I_B = -80\text{ mA}$			-0.5	V
Base-emitter saturation voltage	$V_{BE(sat)}$	$I_C = -800\text{ mA}, I_B = -80\text{ mA}$			-1.2	V
Base-emitter voltage	V_{BE}	$V_{BE} = -1V, I_C = -10\text{ mA}$			-1	V
Transition frequency	f_T	$V_{CE} = -10V, I_C = -50\text{ mA}, f = 30\text{ MHz}$	100			MHz
Collector output capacitance	C_{ob}	$V_{CB} = -10V, I_E = 0, f = 1\text{ MHz}$			20	

RATING AND CHARACTERISTIC CURVES

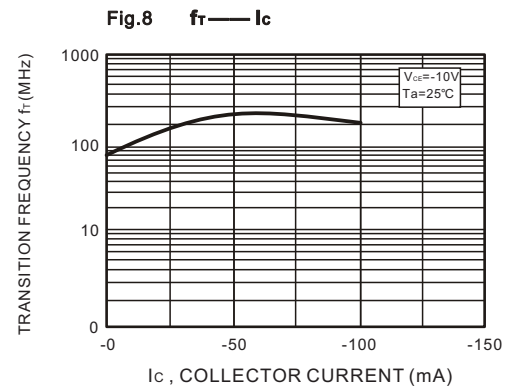
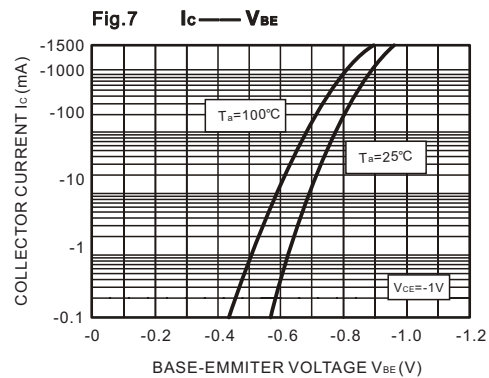
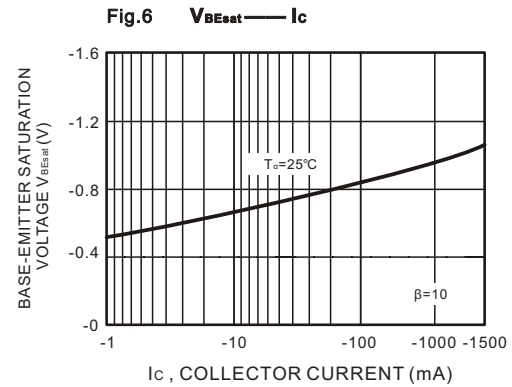
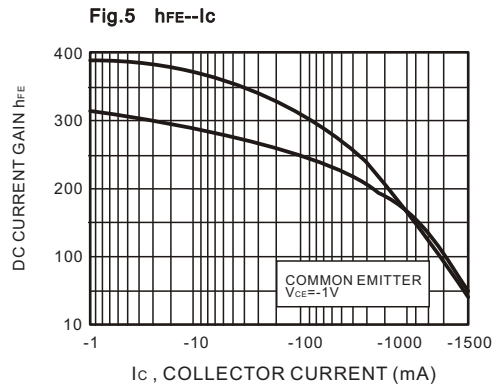
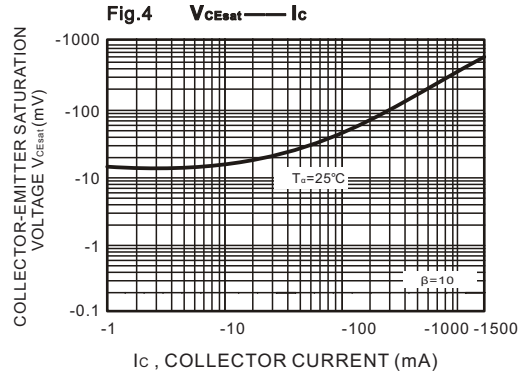
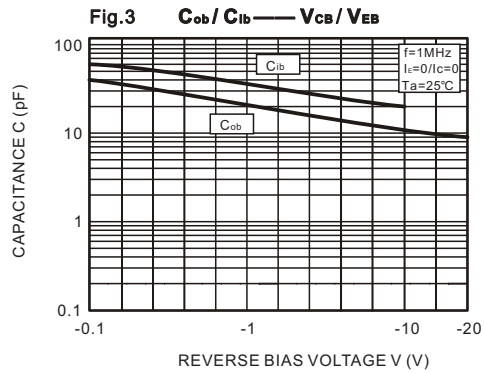
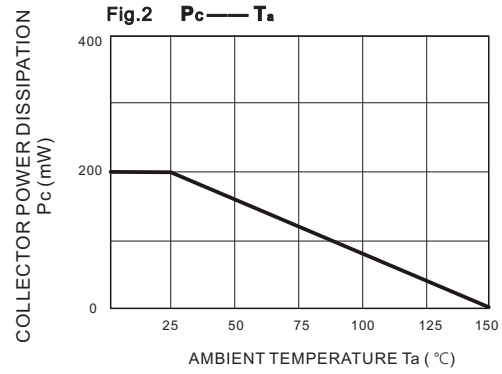
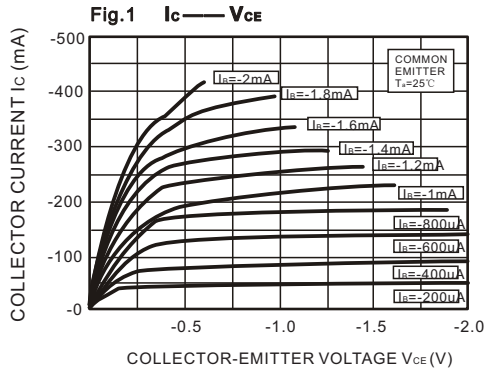

Soldering parameters

Reflow Condition		Pb-Free assembly (see as below)
Pre Heat	-Temperature Min ($T_{s(min)}$)	+150 °C
	-Temperature Max ($T_{s(max)}$)	+200 °C
	-Time (Min to Max) (ts)	60-180 secs.
Average ramp up rate (Liquid us Temp (T_L) to peak)		3 °C/sec. Max
$T_{s(max)}$ to T_L - Ramp-up Rate		3 °C/sec. Max
Reflow	-Temperature (T_L) (Liquid us)	+217 °C
	-Temperature (t_L)	60-150 secs.
Peak Temp (T_P)		+260(+0/-5) °C
Time within 5 °C of actual Peak Temp (t_p)		30 secs. Max
Ramp-down Rate		6 °C/sec. Max
Time 25 °C to Peak Temp (T_P)		8 min. Max
Do not exceed		+260 °C



Package Dimensions & Suggested Pad Layout

SOT23

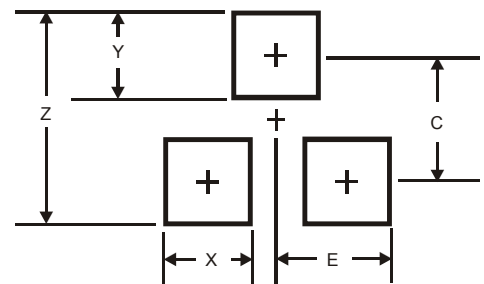
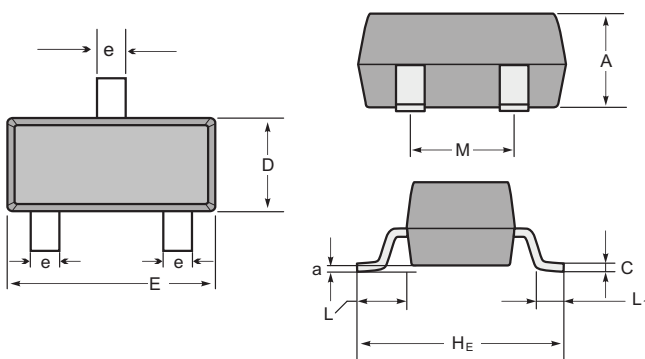

SOT-23 mechanical data

UNIT		A	C	D	E	H_E	e	M	L	L_1	a
mm	max	1.1	0.15	1.4	3.0	2.6	0.5	1.95	0.55 (ref)	0.36 (ref)	0.0
	min	0.9	0.08	1.2	2.8	2.2	0.3	1.7			0.15
mil	max	43	6	55	118	102	20	77	22 (ref)	14 (ref)	0.0
	min	35	3	47	110	87	12	67			6

Dimensions	SOT23
Z	2.9
X	0.8
Y	0.9
C	2.0
E	1.35

Tape & reel specification

Tape

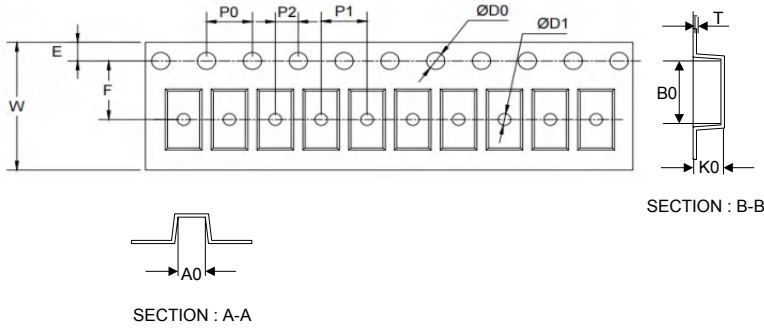

Symbol	Dimension (mm)
P0	4.00±0.10
P1	4.00±0.10
P2	2.00±0.10
D0	1.55±0.10
D1	1.05±0.10
E	1.55±0.10
F	3.60±0.10
W	8.00±0.10
A0	3.80±0.20
B0	3.25±0.20
K0	1.45±0.10
T	0.25±0.05
D2	178.0±3.0
D3	55Min.
D4	R24.0±3.0
G	R82.0±3.0
I	13.0±2.0
W1	11.0±3.0

7" Reel



Quantity: 3000PCS